

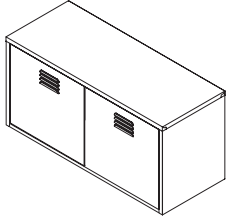





Storage Locker Parts & Hardware

A		x 1 PC
B		x 2 PCs
C		x 2 PCs
D		x 4 PCs
E		x 4 PCs
F		x 2 PCs
G		x 2 PCs
H		x 4 PCs

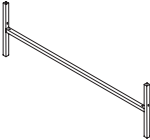
Garden Trading®

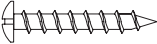
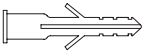
Marlborough Storage Locker Assembly Instructions

Please read through these instructions and ensure they are kept for future reference.
All parts and hardware are listed on the back of this guide.

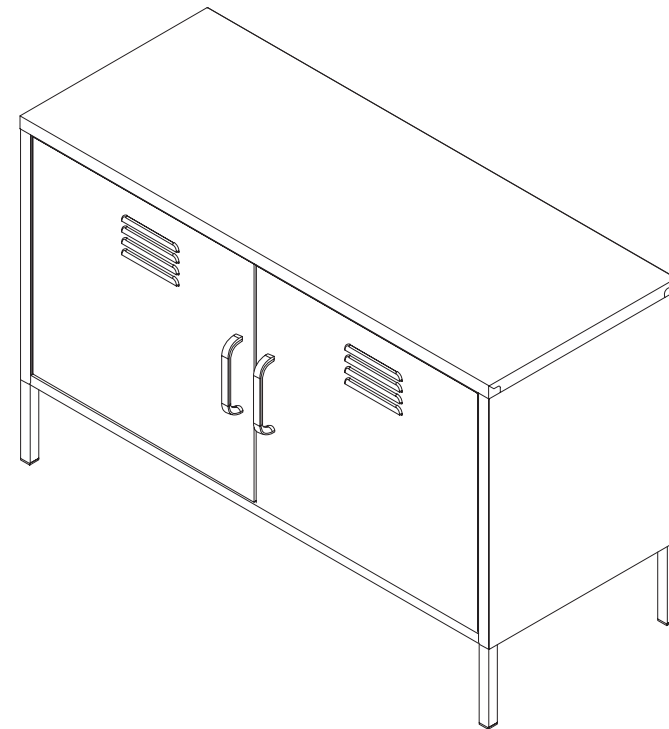

Storage Locker Care Instructions

Dust regularly with a clean dry cloth.

Wipe up any spills immediately with a damp cloth and then dry the surface with a clean dry cloth.

Never use abrasive or corrosive cleaning agents.

Always use place mats and coasters to protect the surface from moisture and heat. Avoid sharp objects scratching the surface.

Avoid placing on uneven surfaces.

Do not drag furniture, always lift to move.

Customer Services:

gardentrading.co.uk

+44 (0)1993 845 559

customerservices@gardentrading.co.uk

Opening Hours: Monday - Friday: 8.30am - 5.30pm (Friday close at 5.00pm)

The Garden Trading Company Ltd, Carterton South Industrial Estate, Black Bourton Road, Carterton, Oxon, OX18 3EZ

Garden Trading®

To remove the legs from inside the unit, please take off one of the doors and carefully manipulate the legs out.

